

PRODUCT SHEET



TANK	
LENGTH	1205 MM
WIDTH	1000 MM
HEIGHT	750 MM

**PRODUCT CODE:
PTCTDI600**

600L DIESEL TRANSPORT TANK

FEATURES

- Cast diesel lid with lockable inlet mesh filter, 4m earth strap and breather
- Heavy duty construction (built to last)
- Manufactured from UV stabilised virgin grade materials (not recycled)
- Secure mounting points in each leg
- 2 year warranty
- Tanks manufactured from Diesel grade material to AS 2809.2.2008
- Outlet fittings available in sizes 1", 1½" or 2"

COLOURS AVAILABLE



Grey

NB: Colours may vary due to screen and printer calibrations.

FREE INCLUSIONS

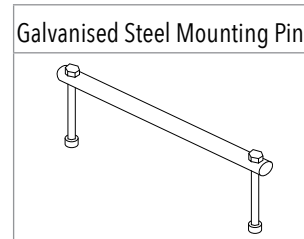
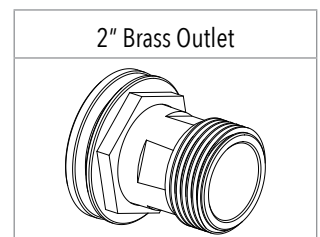
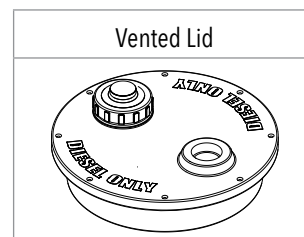

*Inclusions may change without notice, check with sales prior to ordering.

OPTIONAL EXTRAS

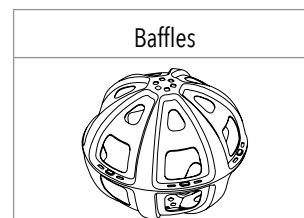

*Various outlet types and sizes also available, please contact sales for a free quote.

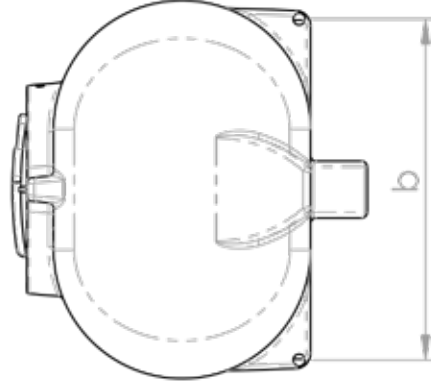
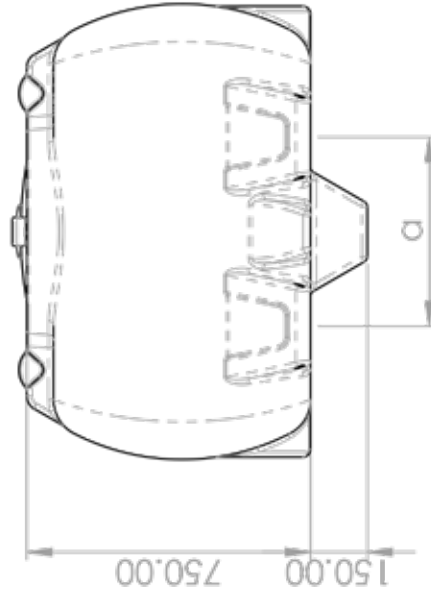
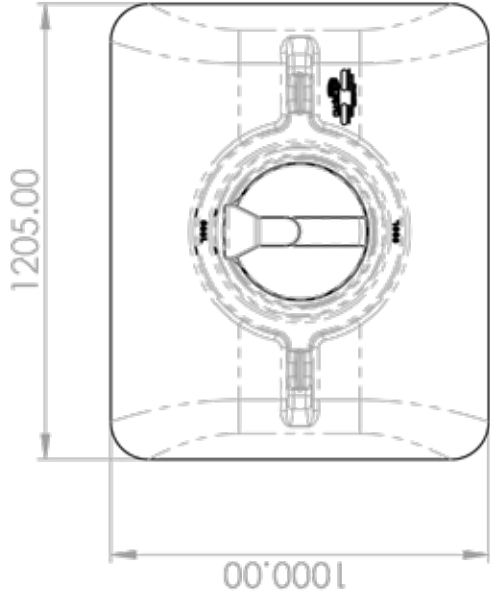

Leg Pitch (a)	Foot Pin Pitch (b)
500 mm	902 mm



PRODUCT CODE:

PTCTDI00

DESCRIPTION:

600 LITRE DIESEL CARTAGE TANK