

Premium SUPPLIER OF
WATER, DIESEL, MOLASSES STORAGE
& LIVESTOCK FEEDING SOLUTIONS

nu-tank
CLEAN • STRONG • RELIABLE
Est. 2008
THE Queensland
TANK

PRODUCT GUIDE
23/24

1300 36 11 10

www.nutank.com.au

FAMILY OWNED • QUEENSLAND MADE



ROUND WATER & SLIMLINE TANK COLOURS

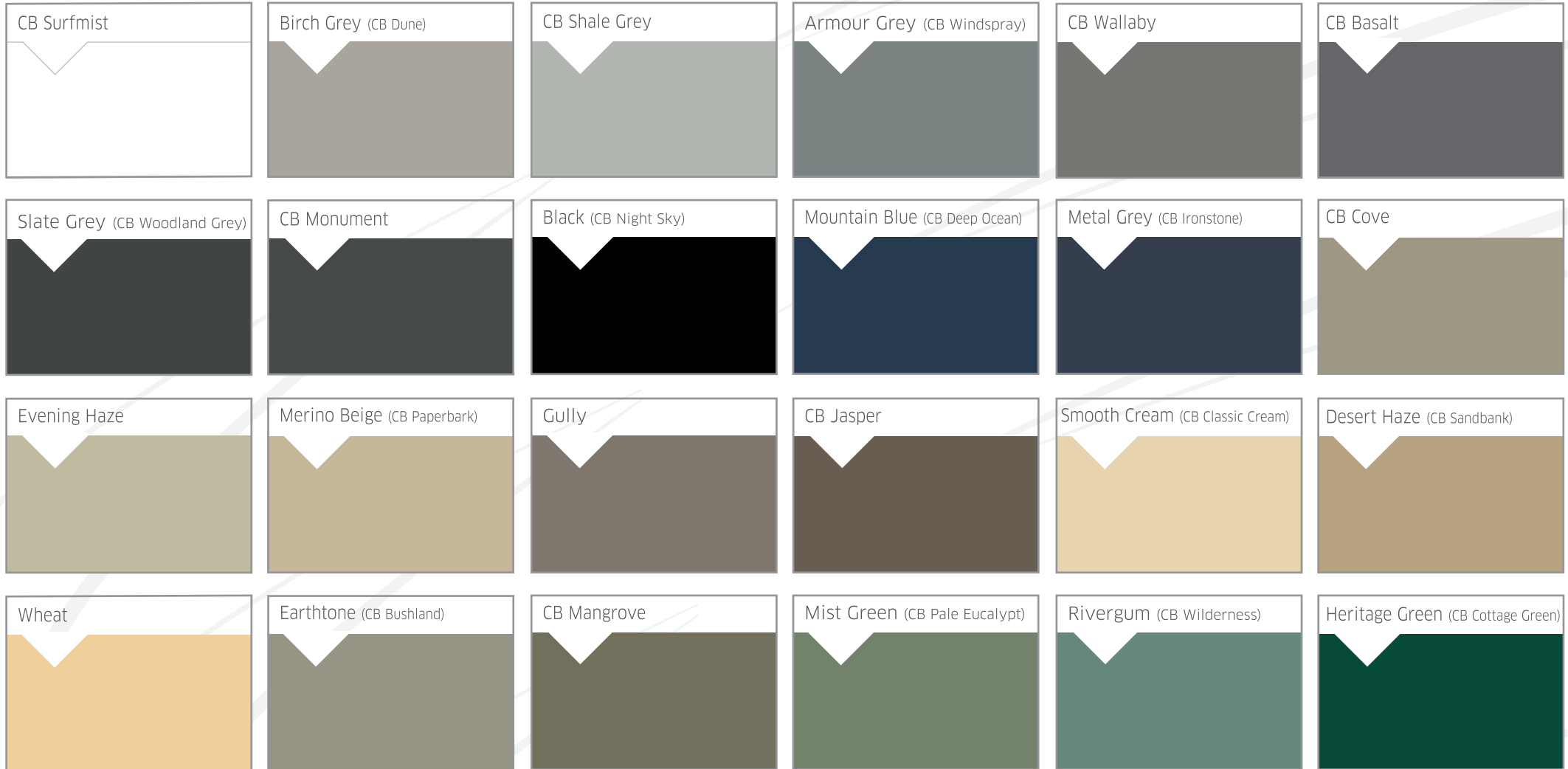

Did you know?

Our colours are matched to the COLORBOND® range. Ask our friendly Product Consultants for help matching the right colour when you order. (COLORBOND® and colour names are registered trademarks of BlueScope Steel Limited®. Colour names, shown in brackets, are trademarks of BlueScope Steel Limited). Note: Colours displayed are representations only, shade variation may occur due to printing conditions.

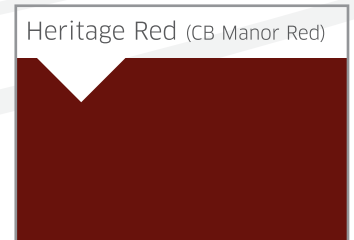

YOUR 6 POINT TANK CHECKLIST



1
A FAMILY OWNED REGIONAL QLD MANUFACTURER



2
RIBBED SIDE WALLS



3
POLY FUSED & WELDED OUTLET FITTING



4
SELF SUPPORTING ROOF



5
COOKED IN COMPUTERISED OVENS



6
THICKER WALLS AT THE BASE

1
AUSSIE MADE
Nu-Tank uses proven, food grade materials, BPA free and heavy metal free in the manufacturing of our tanks, troughs and feeders. UV stabilised, these materials have been proven over time to withstand Australia's harshest conditions.

2
RIBBED SIDE WALLS
Imagine if your body didn't have ribs. Ribs protecting your vital organs. Ribs providing strength and structure to the body. It is similar with a tank, ribs ensure the integrity of the tank is sustained. Strength and structure, all contributing to the reliability, you can be confident of getting from Nu-Tank.

3
POLY FUSED & WELDED OUTLET FITTINGS
The outlet is typically placed towards the bottom of the tank, where, as the tank fills, the greatest pressure is exerted. Brass fittings for the outlet pipe/valve have proven to be the major contributor to a problem commonly known as fitting split. Continual pressure on the foreign material drilled into the tank can cause a small split to occur, above or below the brass fitting, spreading as the fluid escapes. To eliminate fitting split Nu-Tank ingeniously poly fuse the poly outlet to the entire thickness of the wall of our larger tanks, then weld around the outlet. Effectively this makes the poly outlet, one with the poly tank. No brass fittings, no fitting split. Consider a 10200 gallon (45995 litre) molasses tank will hold over 70 tonnes of pressure when full. Gravity forcing it to push against the walls of the tank, looking for a way to escape. A poly fused and welded outlet is a much safer way, over time, to hold your precious asset.

5
COOKED IN COMPUTERISED OVENS
To make a tank the raw materials are heated, whilst also being rotated, to form the desired shape and size, then allowed to cool. You would expect this to be done only in controlled conditions to get the best, most consistent results. Not so, Nu-Tank is one of only a few tank manufacturers in Australia that make all our tanks in computerised ovens. Many manufacturers still cook their tanks over an open flame. The comparison is like cooking in a modern commercial kitchen to over a camp fire. Nu-Tank have made this substantial investment in equipment and technology to give the reliability promised, when you buy one of our products.

6
THICKER WALLS AT THE BASE
As a tank is filled pressure builds within, against the walls, as gravity tries its best to force the stored liquid to spread out, not build upwards. The greatest pressure is towards the base of the tank. The actual base of the tank will have the pad under it to handle this pressure (hence the importance of a well-built pad), but the walls must rely on their own built-in strength (thickness). The technology Nu-Tank uses in the manufacturing of our tanks allows us to make the walls thicker towards the base. Giving you a tank with thicker walls, where it counts the most. Strength and reliability are not just words with Nu-Tank, they are at the heart of how your tank is made. All polyethylene tanks are not the same, because they are not manufactured to be the same.



4
SELF SUPPORTING ROOF
Whereas the greatest internal pressure on a tank is towards the base, the least is at the top, the roof. Tempting some manufacturers to make their tanks with flimsy roofs that need internal support to hold them up, to save on material costs, by using less. Nu-Tanks tank roofs are self-supporting. They do not need, nor have, any internal poles/support to hold them up. The benefit of this is that there is no pole putting continual pressure on a flimsy roof, should a tree branch fall on the roof, there is less likelihood of the roof of the Nu-Tank breaking. Less likelihood of vermin being able to now enter via a hole in the roof. Less likelihood of the vermin using the internal pole to access and contaminate the stored water. Plus, there is no chance of an internal pole eventually puncturing the roof of a Nu-Tank. A self-supporting roof gives you confidence that your tank will securely hold the water you collect, for years to come.



Est. 2008

ROUND WATER TANKS

45,995L/10,200GAL

PTRNWA10200



D 4,500mm | IH 3,200mm | OH 3,500mm

28,000L/6,200GAL

PTRNWA6200



D 3,750mm | IH 2,610mm | OH 3,040mm

25,000L/5,500GAL

PTRNWA5500



D 3,700mm | IH 2,290mm | OH 2,630mm

22,700L/5,000GAL

PTRNWA5000



D 3,500mm | IH 2,250mm | OH 2,810mm

20,000L/4,400GAL

PTRNWA4400



D 3,500mm | IH 2,090mm | OH 2,610mm

15,000L/3,300GAL

PTRNWA3300



D 3,200mm | IH 2,100mm | OH 2,320mm

10,000L/2,200GAL

PTRNWA2200



D 2,500mm | IH 2,200mm | OH 2,380mm

10,000L/2,200GAL SQ

PTRNWA2200SQ

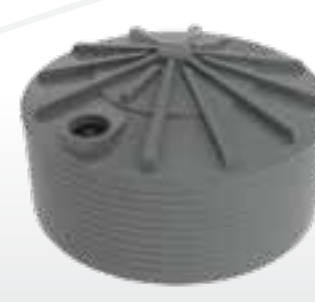

D 3,200mm | IH 1,400mm | OH 1,690mm

8,000L/1,750GAL

PTRNWA1750



D 2,500mm | IH 1,800mm | OH 2,000mm

5,000L/1,100GAL TL

PTRNWA1100TL



D 1,800mm | IH 2,100mm | OH 2,230mm

5,000L/1,100GAL SQ

PTRNWA1100SQ



D 2,500mm | IH 1,160mm | OH 1,410mm

5,000L/1,100GAL ST

PTRNWA11005MH



D 2,150mm | IH 1,500mm | OH 1,700mm

3,500L/750GAL

PTRNWA750



D 1,650mm | IH 1,650mm | OH 1,850mm

3,000L/660GAL

PTRNWA660



D 1,400mm | IH 2,095mm | OH 2,175mm

2,500L/550GAL SQ

PTRNWA5500SQ

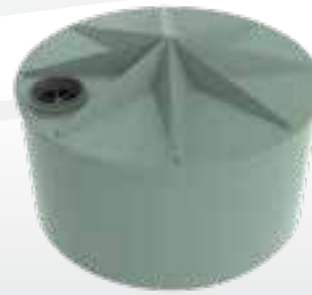

D 1,800mm | IH 1,000mm | OH 1,200mm

2,000L/450GAL

PTRNWA450



D 1,170mm | IH 1,850mm | OH 1,920mm

1,500L/330GAL

PTRNWA330



D 1,250mm | IH 1,310mm | OH 1,310mm

1,200L/260GAL

PTRNWA260



D 1,200mm | IH 1,200mm | OH 1,270mm

570L/125GAL

PTRNWA125



D 875mm | IH 1,000mm | OH 1,000mm

Nu-Tank's Round Water Tanks come with...

Standard inlet, outlet and overflow at **no extra cost.**
*Additional fittings available.
Prices on application.

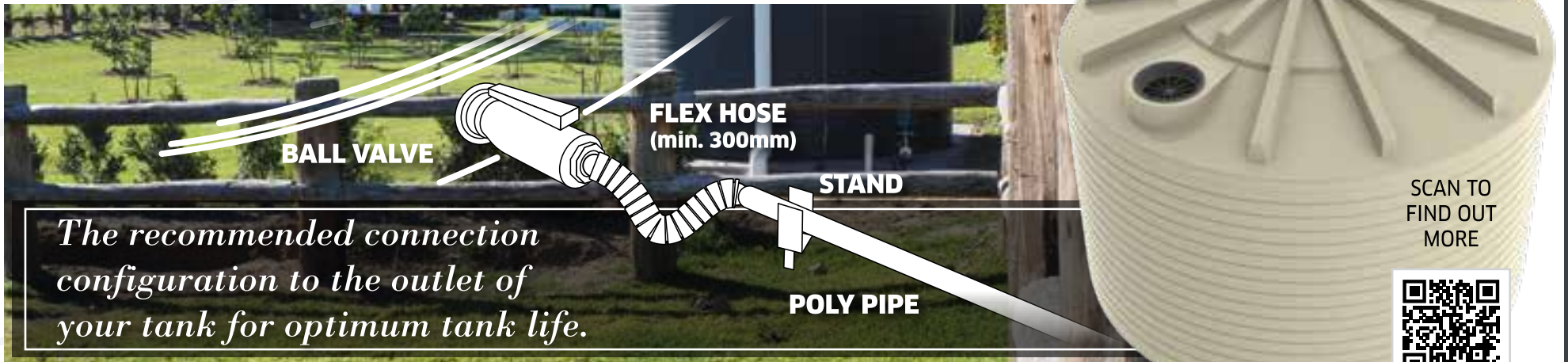

The recommended connection configuration to the outlet of your tank for optimum tank life.

SCAN TO FIND OUT MORE



SLIMLINE WATER TANKS



SCAN TO
FIND OUT
MORE



3,000L Tanks shown

Perfect for Urban Living

Perfect for smaller areas, beside houses, in courtyards and even behind the shed. Save on your water bill and keep that grass green! Designed to slide into narrow spaces but hold a good deal of water. Reduce your carbon footprint and add value to your property with a Nu-Tank Slimline water tank.

5,000L
PTSLWA5000



L 2,800mm | W 1,200mm | H 1,900mm

3,000L
PTSLWA3000



L 2,520mm | W 810mm | H 2,130mm



3,000L featured



SCAN TO
FIND OUT
MORE



4,000L SEPTIC

SE4000BLK



D 1,998MM | OH 2,430MM

3,200L SEPTIC

SE3200BLK



D 1,998MM | OH 2,030MM

SEPTIC FEATURES

- Lightweight only 122kg (3200L)
- Foot trafficable when installed (stops tampering)
- Easy to transport and install
- Made from UV stabilised polypropylene structural foam (toughest injection moulded septic on the market)
- Supplied as complete kit (including inlet and outlet T-piece)



1,200L GREY WATER

PGW1200



D 1,100MM | OH 1,855

900L GREY WATER

PGW900



D 1,100MM | OH 1,370MM

700L GREY WATER

PGW700



D 1,100MM | OH 1,060MM

GREY WATER FEATURES

- Child safe access point
- Foot trafficable when installed (stops tampering)
- Heavy duty (constructed for underground use)
- Widened foot design (to eliminate uplift)
- Easily installed
- Made with proven, food grade materials. BPA Free and heavy metal free
- Supplied as complete kit (including inlet and outlet T-piece)

All dimensions may vary by + or - 3%

SEPTIC & GREY WATER

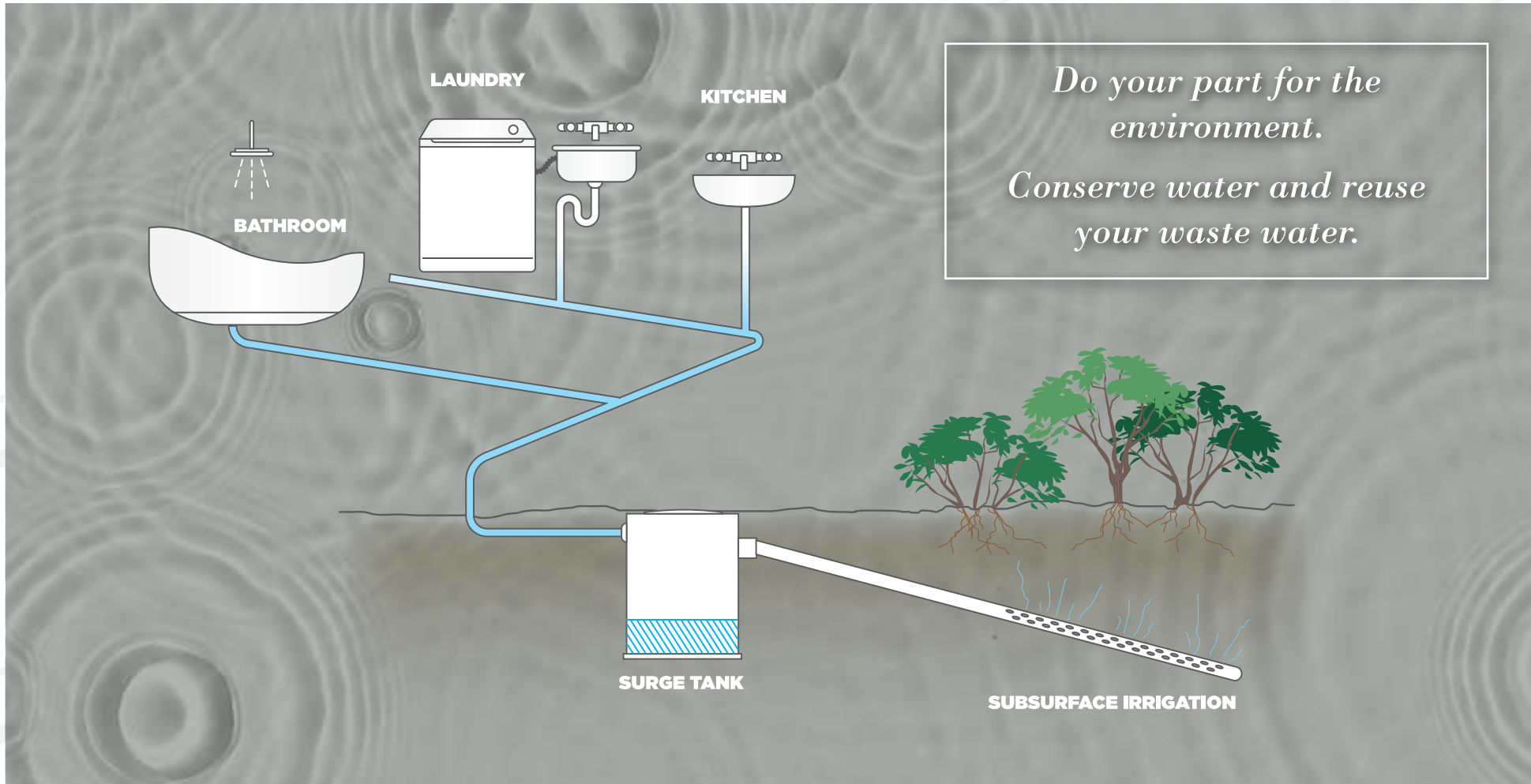

STEEL WATER TANKS



SCAN TO
FIND OUT
MORE



Steel Water Tanks

Need to hold large volumes of water? A Steel water tank could be your solution. Nu-Tank supply and install Streamline and Corrugated water tanks. Made from Bluescope ZINCALUME® or COLORBOND® steel with an ARMA Fresh Liner. Certified as a food grade water tank liner.

STREAMLINE				
PRODUCT CODE	GALLONS	LITRES	HEIGHT	DIAMETER
HGT 55	12,028	54,682	2.31m	5.49m
HGT 75	15,639	71,097	2.31m	6.26m
HGT90	19,891	90,430	2.31m	7.06m
HGT 110	24,529	111,515	2.31m	7.84m
HGT 135	29,722	135,121	2.31m	8.63m
HGT 160	35,338	160,650	2.31m	9.41m
HGT 188	41,357	188,017	2.31m	10.18m
HGT 220	48,201	219,128	2.31m	10.99m
HGT 250	55,286	251,336	2.31m	11.77m
HGT 285	62,856	285,752	2.31m	12.55m



CORRUGATED				
PRODUCT CODE	GALLONS	LITRES	HEIGHT	DIAMETER
CT6	6,026	27,396	2.27m	3.92m
CT9	8,663	39,383	2.27m	4.70m
CT12	11,820	53,735	2.27m	5.49m
CT15	15,368	69,866	2.27m	6.26m
CT20	19,547	88,864	2.27m	7.06m
CT25	24,105	109,584	2.27m	7.84m
CT30	29,207	132,781	2.27m	8.63m
CT35	34,726	157,868	2.27m	9.41m
CT41	40,641	184,761	2.27m	10.18m
CT48	47,366	215,333	2.27m	10.99m
CT54	54,328	246,984	2.27m	11.77m
CT60	61,768	280,804	2.27m	12.55m
CT70	69,475	315,843	2.27m	13.31m
CT80	77,857	353,947	2.27m	14.09m



*Not available in all areas.

MOLASSES & DUNDER TANKS



SCAN TO
FIND OUT
MORE



45,995L/10,200GAL

PTRNMO10200



D 4,500mm | IH 3,200mm | OH 3,440mm

28,000L/6,200GAL

PTRNMO6200



D 3,750mm | IH 2,610mm | OH 3,040mm

KNOW YOUR TRUCK LOADS

HOW MUCH MOLASSES YOUR TANK CAN HOLD



DOUBLE ROAD TRAIN



SEMI TRAILER

+ THERE'S STILL SPACE TO FILL!



25,000L/5,500GAL

PTRNMO5500



D 3,700mm | IH 2,290mm | OH 2,630mm

15,000L/3,300GAL

PTRNMO3300



D 3,200mm | IH 2,100mm | OH 2,320mm

10,000L/2,200GAL

PTRNMO2200



D 2,500mm | IH 2,200mm | OH 2,400mm

10,000L/2,200GAL SQ

PTRNMO2200SQ



D 3,200mm | IH 1,400mm | OH 1,690mm

8,000L/1,750GAL

PTRNMO1750



D 2,500mm | IH 1,800mm | OH 2,000mm

5,000L/1,100GAL TL

PTRNMO1100TL



D 1,800mm | IH 2,100mm | OH 2,230mm

5,000L/1,100GAL SQ

PTRNMO1100SQ



D 2,500mm | IH 1,160mm | OH 1,410mm

MOLASSES TANK FEATURES

- SG Rating 1.6 (2.0 optional - at added cost)
- Fully self supporting roof (no internal poles or frames)
- Made to last with proven food grade materials, BPA free, heavy metal free.
- Manufactured in computerised ovens (not open flame ovens)
- Ribbed side walls (extra strength)
- Thicker walls at base where the greatest pressure is
- Poly fused & welded fittings (stops fitting split)

MOLASSES & DUNDER TANKS



SCAN TO
FIND OUT
MORE

28,000L/6,200GAL

PTRNDU6200



D 3,700mm | IH 2,610mm | OH 3,040mm

DUNDER TANK FEATURES

- SG Rating 1.2 (2.0 optional - at added cost)
- Fully self supporting roof (no internal poles or frames)
- Made to last with proven food grade materials, BPA free, heavy metal free.
- Manufactured in computerised ovens (not open flame ovens)
- Ribbed side walls (extra strength)
- Thicker walls at base where the greatest pressure is
- Poly fused & welded fittings (stops fitting split)

25,000L/5,500GAL

PTRNDU5500



D 3,700mm | IH 2,290mm | OH 2,630mm

15,000L/3,300GAL

PTRNDU3300



D 3,200mm | IH 2,100mm | OH 2,320mm

*Stop your Dunder settling
with our Recirculation setup*

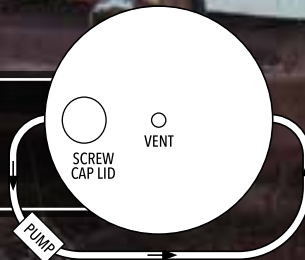

SG Score's!

What is an SG score? It's all about Specific Gravity. Not all liquids weigh the same, and it's important to know and understand this when purchasing a tank to store your liquids. Having a tank without the right SG score could prove costly. At Nu-Tank we go the extra mile by providing tanks that surpass the recommended SG score with a generous safety factor. Learn more about calculating your SG score by watching this video.



The tank
from *'that'*
commercial



Home to Australia's

TOUGHEST Tanks



Our very first
tank. Still going
strong!



Mate vs Mate
State vs State
Tank vs Tank

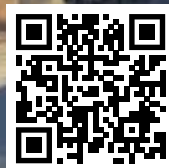

The tank that
survived
Cyclone Marcia

SCAN TO
FIND OUT
MORE



Crossover Trough

A Nu lightweight alternative to concrete. Our Crossover trough has fillable walls, providing the benefit of ballast. Making them hard to mooove when full. Made to last with proven food grade materials, BPA free, heavy metal free, UV stabilised. Easy to transport and easy to maintain.

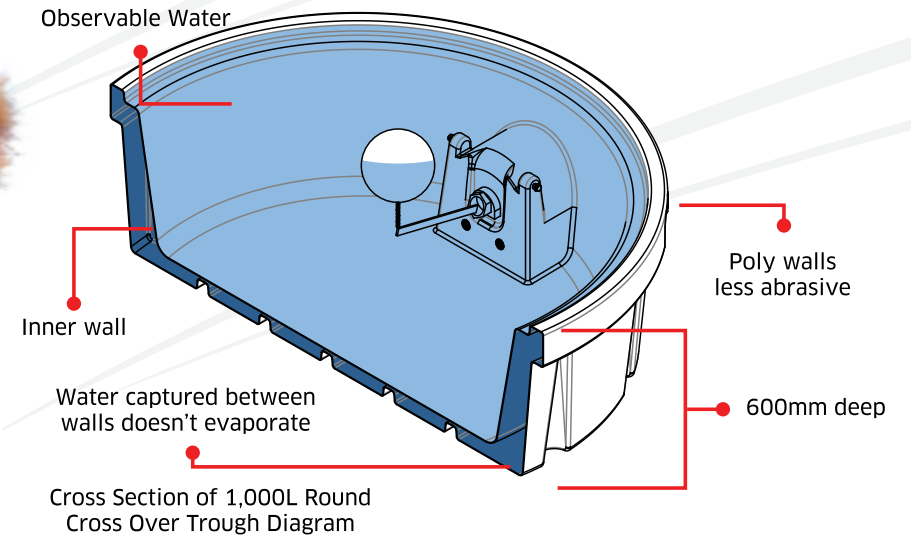

CROSSOVER TROUGH FEATURES

- Made to last with proven food grade materials, BPA free, heavy metal free
- Light to transport when empty
- Stackable for transport and storage
- Less prone to damage due to soil erosion
- Ideal for rotational grazing
- Easier to clean
- Less abrasive on cattle legs than concrete
- Secure float cover
- Easier to maintain correct PH Levels, no lime leeching

1,000L
PORNCO1000



D 1,940mm | H 600mm | OH 815mm



*All made with virgin grade material.
For strength, to last longer,
insist on virgin grade material.*



STACK THEM

FOR EASY
TRANSPORT



LONG AND ROUND
MODELS BOTH
STACKABLE

Ph: 1300 36 11 10 | www.nutank.com.au

All dimensions may vary by + or - 3%

Centreline Troughs

Water your cattle either side of the fence, with our new Centreline troughs. Made with proven food grade materials, BPA free, heavy metal free. These troughs are both practical and made to last.

400L
POLNCL400



L 2,400mm | W 600mm | H 400mm | OH 560mm

200L
POLNCL200

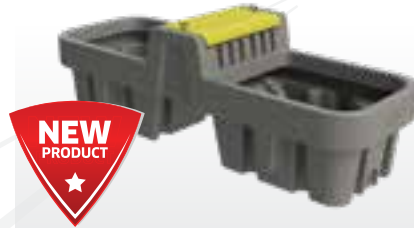

L 1,700mm | W 600mm | H 400mm | OH 560mm



CENTRELINE TROUGH FEATURES

- Water on both sides of the float
- 1" Float in middle under secured cover
- 2" Drain bungs at either end
- Heavy Duty, UV stabilised polyethylene
- Made to last with proven food grade materials, BPA free, heavy metal free
- Easy to maintain

750L
POLNWA750



H 510mm | L 2,350mm | W 910mm

750L FEATURES

- Patented Safety Tread floor (allows stock to regain footing, preventing stock loss and injuries)
- 2" low pressure float valve and 3" drain
- Float cover extends to base of trough (stops tampering when filling)
- Unique anti-crack lip design
- Raised float cover allows to fully fill
- Heavy duty construction
- Made to last with proven food grade materials, BPA free, heavy metal free
- Stackable for easy transport and storage



2,000L

PORNWA2000



D 2,210mm | H 600mm

1,200L

PORNWA1200



D 1,850mm | H 580mm

600L

PORNWA600



D 1,435mm | H 560mm

220L

PORNWA220



D 1,150mm | H 450mm

Round Troughs

The life of a water trough can be rough. Sitting all day in the hot Australian sun, then add a bustling, rough and tumble herd. This is why Nu-Tank make their troughs tough. Tough to last the harsh Australian climate and tough to last the herd, with its anti-crack lip design. But also very importantly our water troughs are made with proven food grade BPA and Heavy Metal free materials.

It's better for them and ultimately you in the long run.

ROUND TROUGH FEATURES

- 2" low pressure float valve and 3" drain (220L has 1" high pressure float valve)
- Float cover extends to base of trough (stops tampering when filling)
- Unique anti-crack lip design
- Raised float cover allows trough to fill right to the top
- Heavy duty construction
- Made to last with proven food grade materials, BPA free, heavy metal free
- Smooth internal surface for easy cleaning
- Stackable for transport and storage
- Easily relocatable

1,200L WHEEL LICK FEEDER

PFWLMO1200



D 2,060MM | H 820MM

600L WHEEL LICK FEEDER

PFWLMO600



D 1,560MM | H 820MM

WHEEL LICK FEEDER FEATURES

- Heavy duty construction
- Keeps the weather out and lick protected from the elements
- Raised trough center ensuring lick drains to wheels
- Side fill point in 1,200L only for easy access
- 4 x Licker wheels allowing more cattle to feed at one time
- Wheels run sideways to mimic cattle's natural licking motion
- Wheels run to bottom of trough ensuring all liquid can be consumed
- Made to last with proven food grade materials, BPA free, heavy metal free.



SCAN TO FIND OUT MORE



Replacement Wheels and Screwcap lids/hatches available.

DRY LICK FEEDER

KDLF650

H 1,831mm | W 2,400mm



SCAN TO FIND OUT MORE

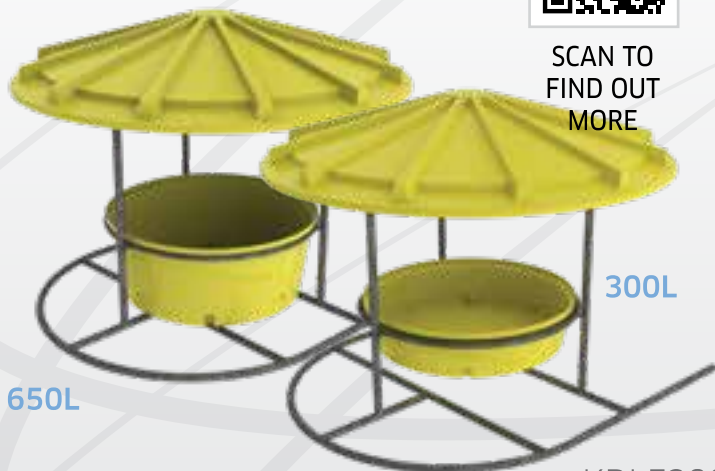

650L

300L

KDLF300

H 1,831mm | W 2,400mm

DRY LICK FEEDER FEATURES

- Tow-able frame design for short distances over suitable ground (when empty)
- Galvanised frame
- Made to last with proven food grade materials, BPA free, heavy metal free.
- Roof and trough can be purchased individually

ROLLER DRUM FEATURES

- Heavy duty construction
- Prevents weather damage of feed
- Designed to control livestock intake
- Made to last with proven food grade materials, BPA free, heavy metal free.
- Manufactured in computerised ovens
- Removable drum

150L ROLLER DRUM

PFRDMO150



SCAN TO FIND OUT MORE



L 880mm | W 710mm | OH 435mm

2,500L
PORNMO2500FF



D 2,500mm | H 500mm

1,500L
PORNMO1500ST

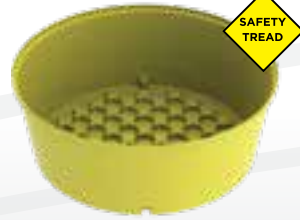

D 1,800mm | H 680mm

1,000L
PORNMO1000ST

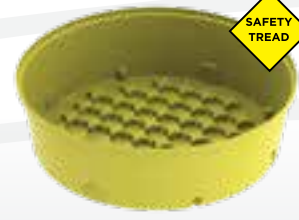

D 1,800mm | H 500mm

750L
PORNMO750ST



D 1,540mm | H 500 mm

650L
PORNMO650ST

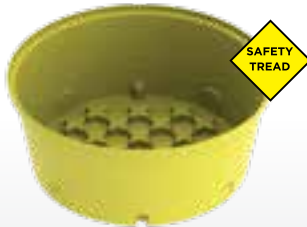

D 1,370mm | H 550mm

650L
PORNMO650FF



D 1,370mm | H 550mm

500L
PORNMO500ST



D 1,260mm | H 520mm

TROUGH FEATURES

- Unique anti-crack lip design
- Made to last with proven food grade materials, BPA free, heavy metal free
- Stackable for transport and storage
- Easily relocatable
- Heavy duty construction (won't crack or perish)
- Stops moulded in the base for stacking (stops suction)

400L
PORNMO400FF



D 1,300mm | H 400mm

300L
PORNMO300FF



D 1,255mm | H 300mm

200L
PORNMO200FF



D 1,100mm | H 300mm

50L
PORNMO50FF

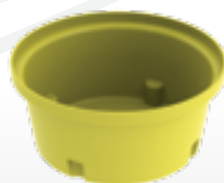

D 650mm | H 300mm

Amazing Patented Safety Tread Troughs

Keep your animals fed and safe with a Nu-Tank Patented Safety Tread Trough.

Built with a moulded pattern in the floor that enables fallen animals to regain their footing. Helping to prevent injuries and drowning of your stock.



SCAN TO FIND OUT MORE

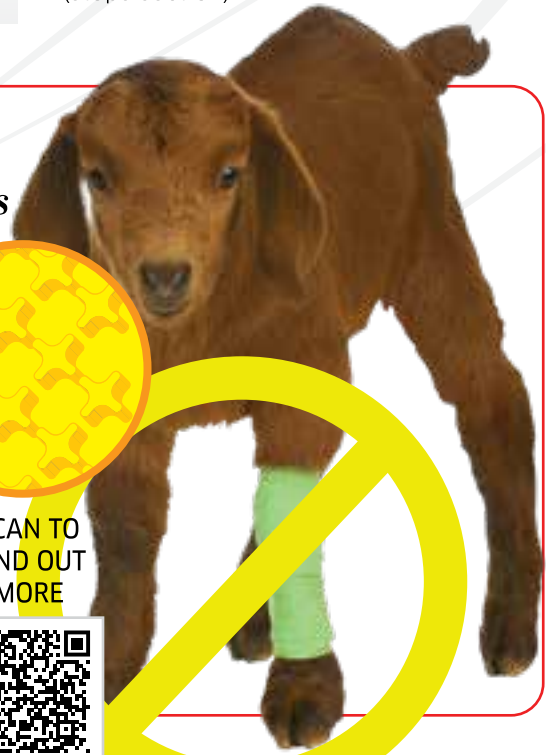

HORSE FEEDERS



SCAN TO
FIND OUT
MORE

“

Here at RDA we love the Nu-Tank hay feeder. It is sturdily constructed and built to last with safety in mind, its 'horse proof'! When using the feeder our horses have easy access to their hay and the handy catcher at the base reduces waste by preventing hay being dropped and spoiled on the ground.

”

- LOUISE
HORSE CARE MANAGER
RDA ROCKHAMPTON



35L D FEEDER

PFDF35

Fence Feeders

Made durable, from proven food grade materials, BPA free, heavy metal free, these fence feeders are built to endure exposure to Australian climates. With galvanised steel mounting brackets they are easy to hook onto your fence rails.



D 420mm | H 250mm | W 400mm

HAY FEEDER

PFHF



D 500mm | H 840mm | W 600mm

FENCE HAY FEEDER FEATURES

- Generous hay compartment - fits one biscuit of hay
- Lid prevents horse pulling biscuit out of hay rack
- Feed bin prevents valuable feed from falling onto ground
- Zinc plated hay compartment frame and galvanised brackets



All dimensions may vary by + or - 3%

Ph: 1300 36 11 10 | www.nutank.com.au

DIESEL TRANSFER TANKS

Transfer your diesel safely with a fully baffled, diesel grade Transfer Tank, complete with pump.



SCAN TO FIND OUT MORE

DIESEL TRANSFER UNIT FEATURES

- Fork points for ease of handling when empty
- Heavy duty Diesel grade tank (material complies with AS1940-2017 and AS2809.2-2020)
- Fully baffled for braking, stability and overall safety when in use
- Earth strap to prevent anti-static build up when filling or dispensing
- Piusi 12V 45L/MIN pump with 4m hose and leads

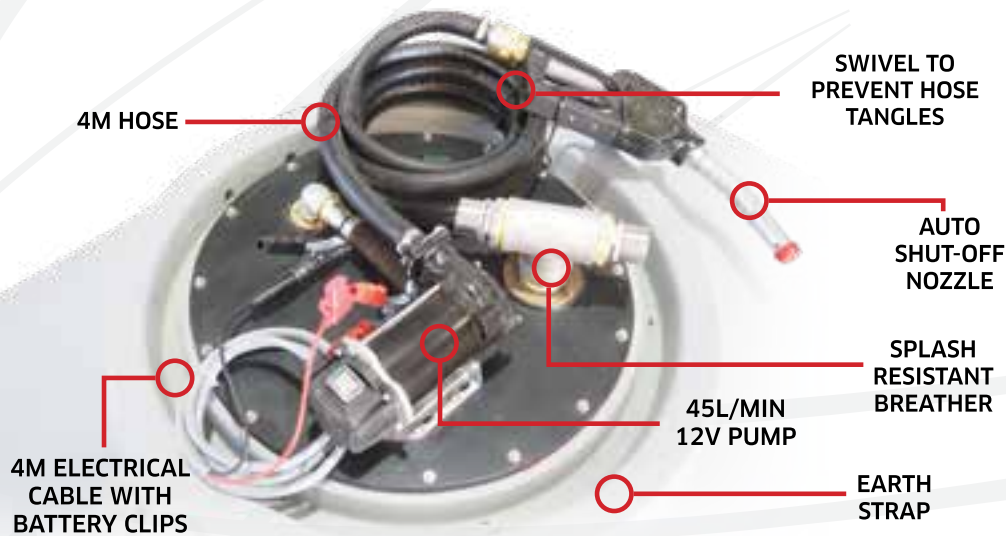

SIZES AVAILABLE

CODE	LITRES	HEIGHT	LENGTH	WIDTH
PMDI2000	2,000L	1,250	1,875	1,420
PMDI1500	1,500L	1,130	1,720	1,330
PMDI1200	1,200L	970	1,720	1,330
PMDI1000	1,000L	1,020	1,450	1,255
PMDI800	800L	865	1,450	1,255
PMDI600	600L	900	1,205	1,000
PMDI400	400L	760	1,205	1,000

DIESEL SLIP ON UNITS

*We've thought of everything...
An easy to transfer, transfer tank!
It comes with a heavy duty frame
with fork pockets.*



SCAN TO
FIND OUT
MORE

SLIP ON DIESEL TRANSFER UNIT FEATURES

- Heavy duty alloy frame (steel frame optional)
- Fork points for ease of handling when empty
- Heavy duty diesel grade tank (material complies with AS1940-2017 and AS2809.2-2020)
- Fully baffled for braking, stability and overall safety when in use
- Earth strap to prevent anti-static build up when filling or dispensing
- Piusi 12V 45L/Min pump with 4m hose (2,000L models and under)
- Honda GX25 120L/MIN pump with 10m hose (2,400L models and above)

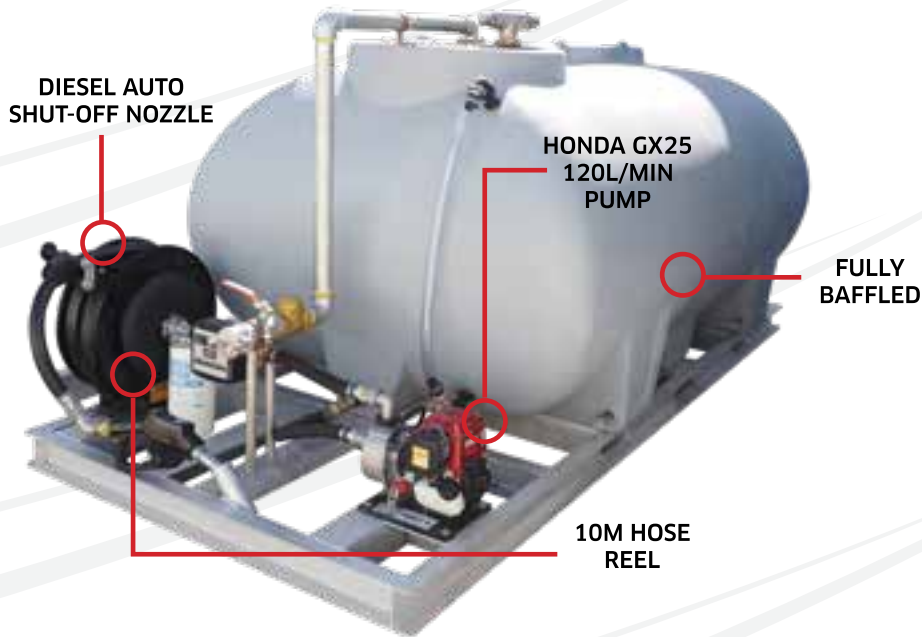

SIZES AVAILABLE

CODE	LITRES	HEIGHT	LENGTH	WIDTH
SODI10000	10,000L	2,025	4,060	2,100
SODI8000	8,000L	1,920	3,850	2,040
SODI7000	7,000L	1,790	3,730	1,900
SODI6000	6,000L	1,820	3,280	1,910
SODI5000	5,000L	1,725	2,795	1,820
SODI4000	4,000L	1,650	2,815	1,700
SODI3000	3,000L	1,500	2,800	1,530
SODI2400	2,400L	1,315	2,780	1,405
SODI2000	2,000L	1,350	1,875	1,420
SODI1500	1,500L	1,230	1,720	1,330
SODI1200	1,200L	1,170	1,720	1,330
SODI1000	1,000L	1,120	1,450	1,255
SODI800	800L	965	1,450	1,255
SODI600	600L	1,000	1,205	1,000
SODI400	400L	860	1,205	1,000

DIESEL STORAGE

**BUY IN BULK &
SAVE!**

**90L/MIN 240V BOWSER
(12/24V AVAILABLE - 80L/MIN
BOWSER)**

**VENTED
DIESEL LID**

**TRUCK
FILL POINT**

**HEAVY
DUTY
ALLOY
FRAME**

**FORK LIFT
POCKETS**

SCAN TO
FIND OUT
MORE



20,000L 240V Unit
model shown

ON FARM DIESEL STORAGE

20,000L

OFSDI20000FBB



L 7,100mm | W 2,500mm | H 2,650mm

10,000L

OFSDI10000FBB



L 3,050mm | W 2,500mm | H 2,650mm

5,000L

OFSDI5000FBB



L 2,400mm | W 1,850mm | H 2,480mm

*Save on Diesel by buying in bulk
and storing it with a Nu-Tank
On-Farm Diesel Storage Tank*

DIESEL ON FARM STORAGE TANK FEATURES

- Specific Gravity of 1.6
- Fully self supporting roof (no internal poles or frames)
- Tanks can be daisy chained for extra storage
- Manufactured in computerised ovens (not open flame oven)
- Thicker walls at base (supports pressure)
- Poly fused & welded fittings (stops fitting split)
- Made to last with proven diesel grade raw materials

TRANSPORT/CARTAGE TANKS

18,000L



L 5,030mm | W 2,380mm | H 2,060mm

15,000L



L 4,020mm | W 2,400mm | H 2,100mm

13,000L LOW PROFILE



L 3,970mm | W 2,260mm | H 1,930mm

13,000L TALL



L 3,730mm | W 2,270mm | H 2,200mm

12,000L



L 3,650mm | W 2,100mm | H 2,100mm

11,000L



L 3,650mm | W 2,120mm | H 2,015mm

10,000L



L 3,600mm | W 2,100mm | H 1,775mm

8,000L



L 3,340mm | W 2,040mm | H 1,670mm

7,000L



L 3,200mm | W 1,900mm | H 1,540mm

6,000L



L 2,790mm | W 1,910mm | H 1,570mm

5,000L



L 2,350mm | W 1,820mm | H 1,475mm

4,000L



L 2,400mm | W 1,700mm | H 1,400mm

3,000L



L 2,320mm | W 1,530mm | H 1,250mm

2,400L



L 2,275mm | W 1,405mm | H 1,065mm

2,000L



L 1,875mm | W 1,420mm | H 1,100mm

1,500L



L 1,720mm | W 1,330mm | H 980mm



SCAN TO
FIND OUT
MORE



STANDARD
COLOURS



ASK ABOUT OUR CUSTOM
COLOUR OPTIONS

1,200L



L 1,720mm | W 1,330mm | H 820mm

1,000L



L 1,450mm | W 1,255mm | H 870mm

800L



L 1,450mm | W 1,255mm | H 715mm

600L



L 1,205mm | W 1,000mm | H 750mm



*Need to transport bulk liquids safely and efficiently?
Baffle Balls STOP surge caused by liquids moving
during transport, making your journey safer.*

Ask about Baffle Balls!

400L



L 1,205mm | W 1,000mm | H 610mm

All dimensions may vary by + or - 3%

Ph: 1300 36 11 10 | www.nutank.com.au

ROUND TANK FEATURES

- SG Rating 1.6 (2.0 optional - at added cost)
- Fully self supporting roof (no internal poles or frames)
- Made to last with proven food grade materials, BPA free, heavy metal free.
- Manufactured in computerised ovens (not open flame ovens)
- Ribbed side walls (extra strength)
- Thicker walls at base where the greatest pressure is
- Poly fused & welded fittings (stops fitting split)

TRANSPORT TANK FEATURES

- ▶ Spill prevention shroud with 455mm hinged lid
- ▶ Heavy duty construction (built to last)
- ▶ Manufactured from UV stabilised virgin grade materials (not recycled)
- ▶ Secure mounting points in each leg
- ▶ Complies with relevant Australian Standards
- ▶ Specific Gravity 1.6 (SG2.0 Optional)
- ▶ Sump available on select sizes

Liquid Fertiliser

Storing and transporting liquid fertiliser around your land. Make it easier and more convenient with Nu-Tank's liquid fertiliser storage and transport solutions.

Specially manufactured tanks rated SG 1.6, with the option of SG 2.0, in a translucent 'natural' colour so there's no extra leg work to check your levels.



SCAN TO
FIND OUT
MORE

A circular inset image showing a white liquid fertiliser tank in a rural setting. The tank is cylindrical with a dark base and a white top section. It is situated on a gravel area with a fence and trees in the background.

AVAILABLE IN 'NATURAL'.
NATURALLY TRANSLUCENT
SO YOU CAN SEE THE LEVEL
OF FLUID INSIDE.



LIQUID FERTILISER ROUND TANKS

10,200GAL/45,995L

PTRNFE10200



D 4,500mm | IH 3,200mm | OH 3,500mm

6,200GAL/28,000L

PTRNFE6200



D 3,750mm | IH 2,610mm | OH 3,040mm

5,500GAL/25,000L

PTRNFE5500



D 3,700mm | IH 2,290mm | OH 2,630mm

Need to transport it too?

LIQUID FERTILISER TRANSPORT TANKS



Available in

18,000L (S) | 15,000L | 13,000L TL (S) | 13,000L
LW | 12,000L (S) | 11,000L (S) | 10,000L | 8,000L (S)
| 7,000L | 6,000L (S) | 5,000L | 4,000L | 3,000L |
2,400L (S) | 2,000L | 1,500L (S) | 1,200L (S)
1,000L (S) | 800L (S) | 600L (S) | 400L (S)



(S) Sump option available

FIRE FIGHTING



SCAN TO
FIND OUT
MORE



FIRE FIGHTER SLIP ON UNITS

A dry summer in Oz means increased fire risk. Be prepared with a Fire Fighter Slip On Unit. Also great for dust suppression!

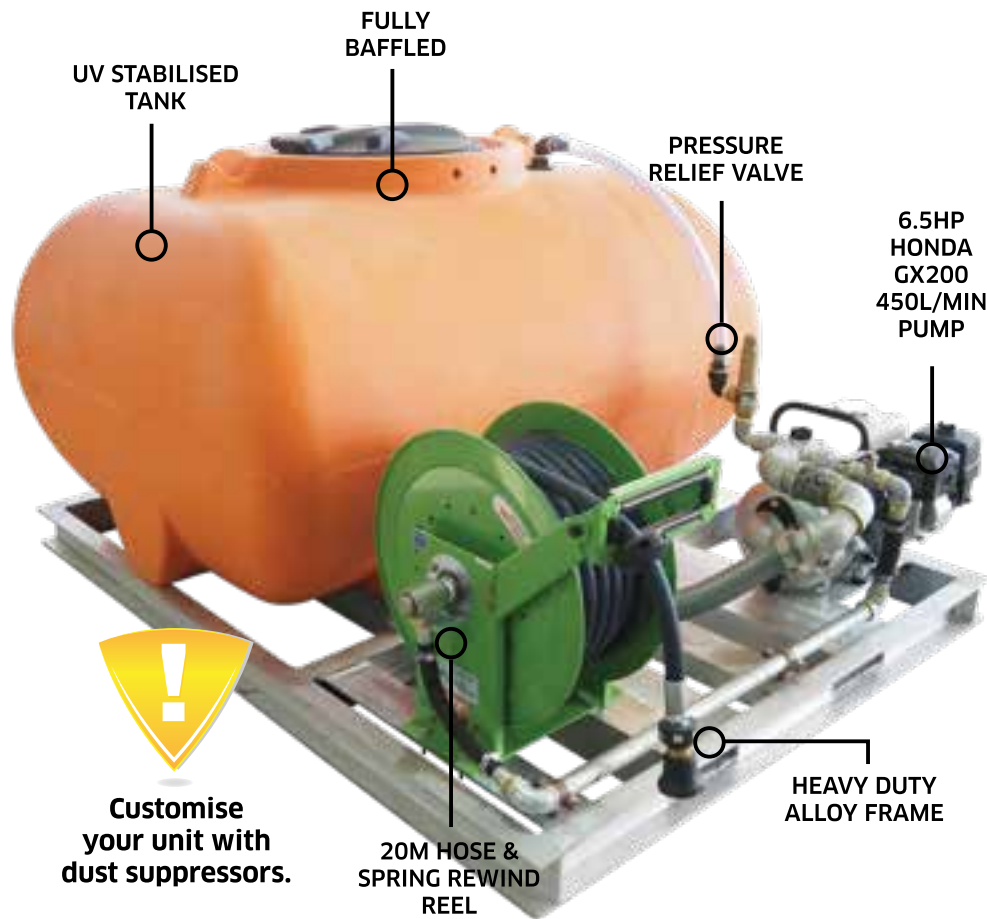

FIRE FIGHTER UNIT FEATURES

- Heavy duty aluminium frame (will withstand the elements)
- Fork points (for ease of handling)
- Full hard plumbing connection (all galvanised, heavy duty and reliable flexible connection between plumbing and tank)
- Pressure relief bypass valve fitted to return excess pressure to tank to ensure safe pump operation
- Heavy duty UV stabilised poly tank (won't rust or corrode)
- Fully baffled for braking, stability and overall safety when in use
- Genuine 6.5HP Honda GX200 with 450L/MIN pump
- Heavy duty 20m x 20mm hose reel with spring rewind and adjustable nozzle

SIZES AVAILABLE

CODE	LITRES	HEIGHT	LENGTH	WIDTH
SOFF2000	2,000L	1,200	2,560	1,490
SOFF1500	1,500L	1,120	1,995	1,715
SOFF1200	1,200L	970	1,995	1,715
SOFF1000	1,000L	1,030	1,905	1,445
SOFF800	800L	865	1,905	1,445
SOFF600	600L	885	1,680	1,245
SOFF400	400L	735	1,680	1,245



nu-tank

CLEAN • STRONG • RELIABLE

Est. 2008

1300 36 11 10

www.nutank.com.au

