

PRODUCT SHEET



TANK	
LENGTH	1450 MM
WIDTH	1255 MM
HEIGHT	870 MM

**PRODUCT CODE:  
PTCTFE1000**

**1,000L LIQUID FERTILISER TRANSPORT TANK**

**FEATURES**

- Spill prevention shroud with 455mm hinged lid
- Heavy duty construction (built to last)
- Manufactured from UV stabilised virgin grade materials (not recycled)
- Secure mounting points in each leg
- Complies with relevant Australian Standards
- Australian Made - Australian Owned
- Specific Gravity 1.6 (SG2.0 Optional)

**COLOURS AVAILABLE**



Natural

NB: Colours may vary due to screen and printer calibrations.

**FREE INCLUSIONS**

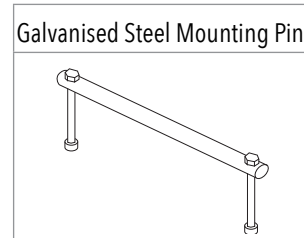
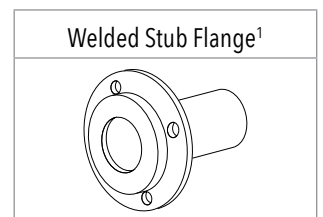
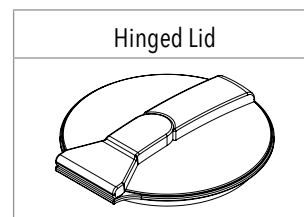

<sup>1</sup> Welded Stub Flange sizes available in 3", 4" and 6"

\*Inclusions may change without notice, check with sales prior to ordering.

**OPTIONAL EXTRAS**

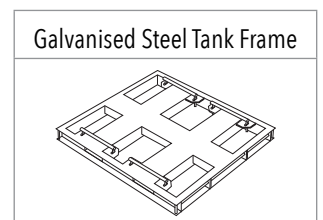
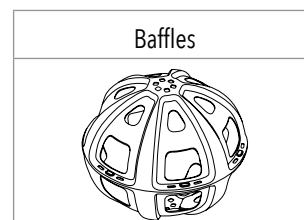

\*Various outlet types and sizes also available, please contact sales for a free quote.

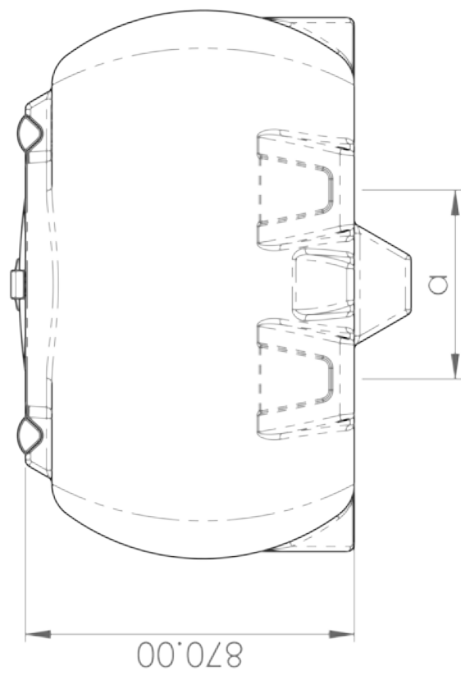
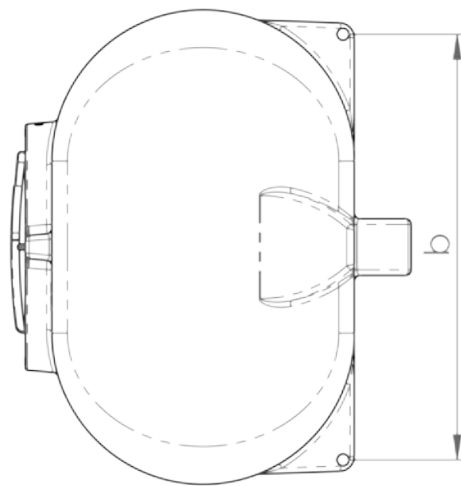
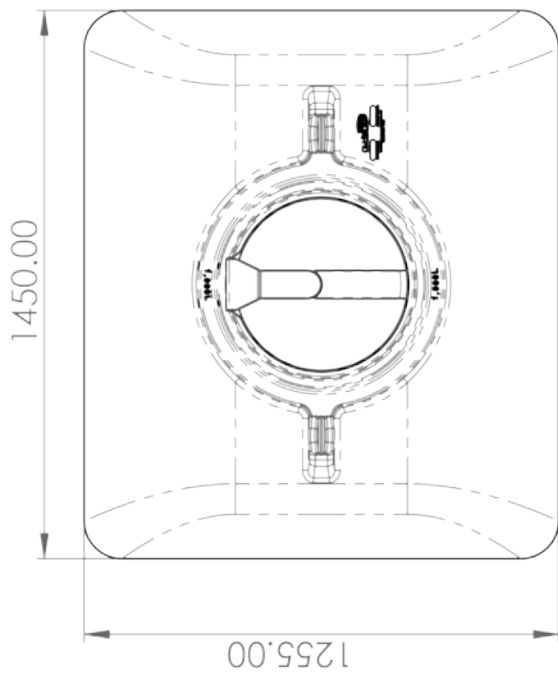

Leg Pitch (a)	Foot Pin Pitch (b)
500 mm	1125 mm



PRODUCT CODE:

PTCTFE1000

DESCRIPTION:

1000 LITRE LIQUID FERTILISER TRANSPORT TANK