

## PRODUCT SHEET



TANK	
LENGTH	1720 MM
WIDTH	1330 MM
HEIGHT	820 MM

**PRODUCT CODE:  
PTCTFE1200**

## 1,200L LIQUID FERTILISER TRANSPORT TANK

### FEATURES

- Spill prevention shroud with 455mm hinged lid
- Heavy duty construction (built to last)
- Manufactured from UV stabilised virgin grade materials (not recycled)
- Secure mounting points in each leg
- Complies with relevant Australian Standards
- Australian Made - Australian Owned
- Specific Gravity 1.6 (SG2.0 Optional)

### COLOURS AVAILABLE



Natural

NB: Colours may vary due to screen and printer calibrations.

### FREE INCLUSIONS

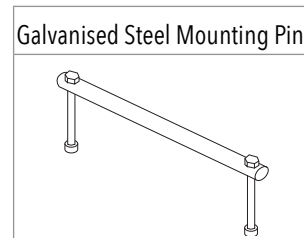
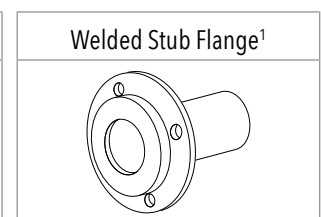
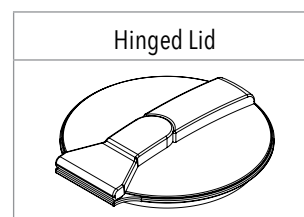

<sup>1</sup> Welded Stub Flange sizes available in 3", 4" and 6"

\*Inclusions may change without notice, check with sales prior to ordering.

### OPTIONAL EXTRAS

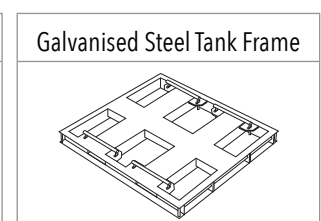
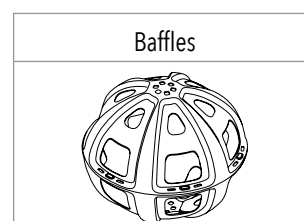

\*Various outlet types and sizes also available, please contact sales for a free quote.

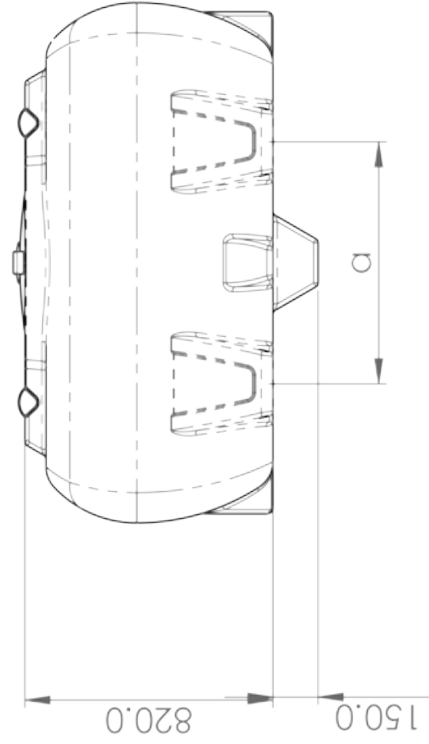
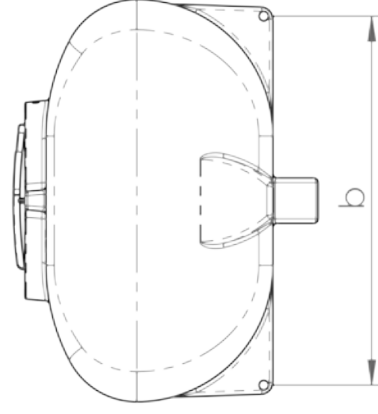
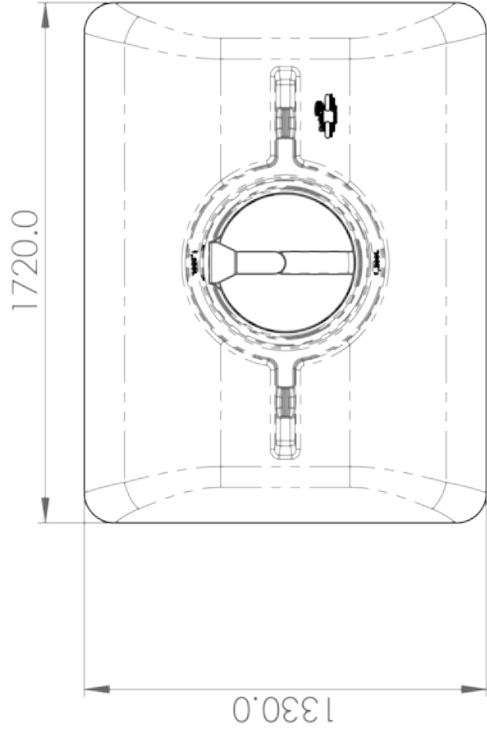

Leg Pitch (a)	Foot Pin Pitch (b)
800 mm	1220 mm



PRODUCT CODE: PTCFFE1200

DESCRIPTION: 1200 LITRE LIQUID FERTILISER TRANSPORT TANK