

PRODUCT SHEET



| TANK | |
|--------|---------|
| LENGTH | 1205 MM |
| WIDTH | 1000 MM |
| HEIGHT | 610 MM |

**PRODUCT CODE:
PTCTFE400**

400L LIQUID FERTILISER TRANSPORT TANK

FEATURES

- Spill prevention shroud with 455mm hinged lid
- Heavy duty construction (built to last)
- Manufactured from UV stabilised virgin grade materials (not recycled)
- Secure mounting points in each leg
- Complies with relevant Australian Standards
- Australian Made - Australian Owned
- Specific Gravity 1.6 (SG2.0 Optional)

COLOURS AVAILABLE



Natural

NB: Colours may vary due to screen and printer calibrations.

FREE INCLUSIONS

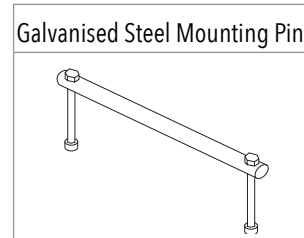
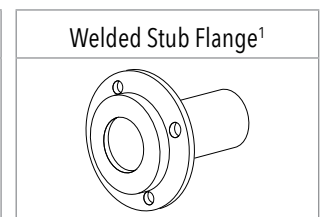
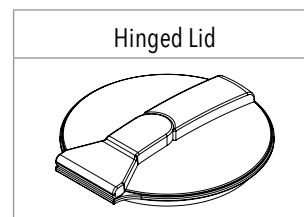

¹ Welded Stub Flange sizes available in 3", 4" and 6"

*Inclusions may change without notice, check with sales prior to ordering.

OPTIONAL EXTRAS

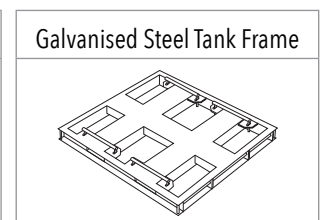
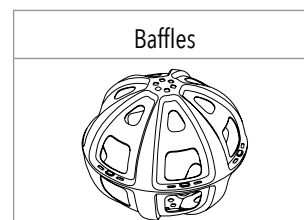

*Various outlet types and sizes also available, please contact sales for a free quote.

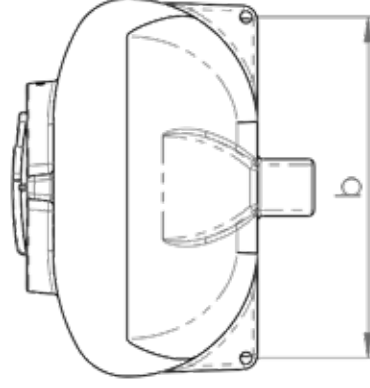
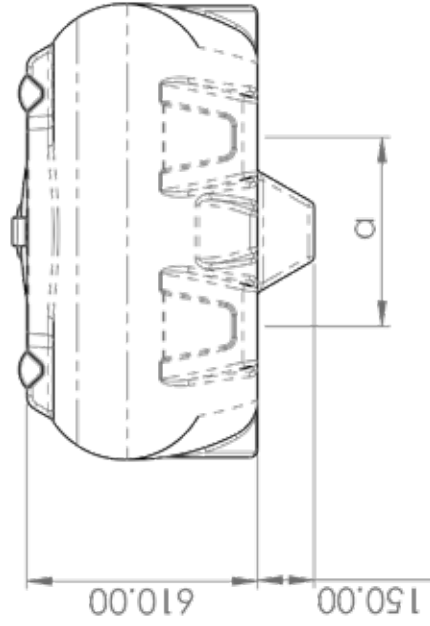
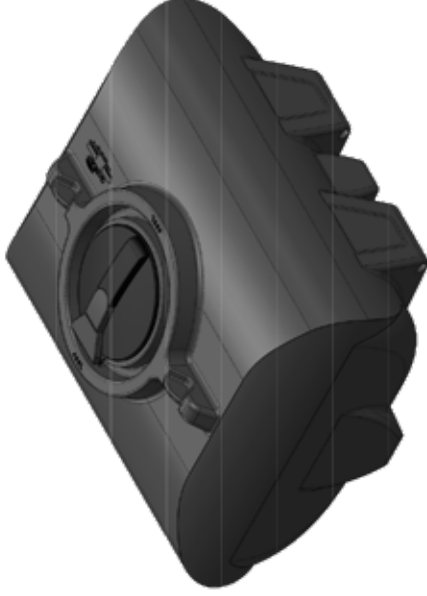
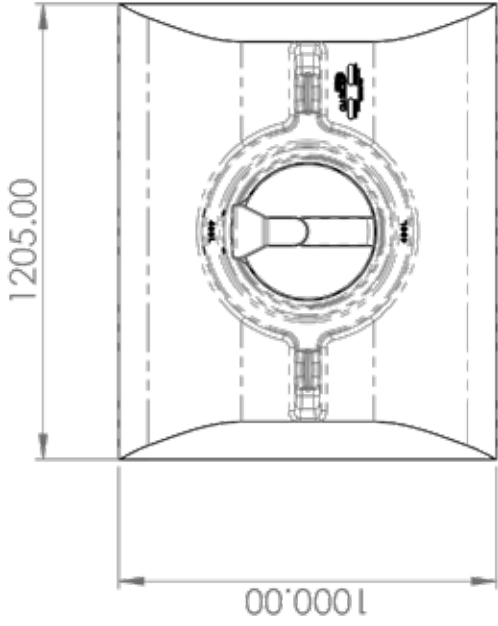

| | |
|---------------|--------------------|
| Leg Pitch (a) | Foot Pin Pitch (b) |
| 500 mm | 902mm |



PRODUCT CODE: PTCIFE400

DESCRIPTION: 400 LITRE LIQUID FERTILISER TRANSPORT TANK