

PRODUCT SHEET



TANK	
LENGTH	1205MM
WIDTH	1000 MM
HEIGHT	750 MM

**PRODUCT CODE:
PTCTFE600**

600L LIQUID FERTILISER TRANSPORT TANK

FEATURES

- Spill prevention shroud with 455mm hinged lid
- Heavy duty construction (built to last)
- Manufactured from UV stabilised virgin grade materials (not recycled)
- Secure mounting points in each leg
- Complies with relevant Australian Standards
- Australian Made - Australian Owned
- Specific Gravity 1.6 (SG2.0 Optional)

FREE INCLUSIONS

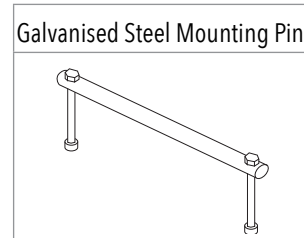
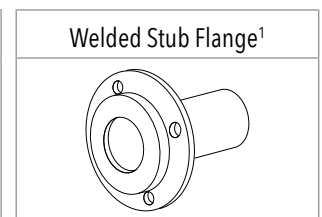
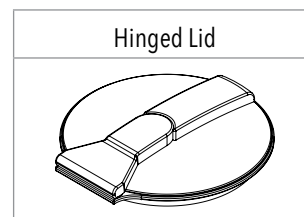

¹ Welded Stub Flange sizes available in 3", 4" and 6"

*Inclusions may change without notice, check with sales prior to ordering.

OPTIONAL EXTRAS

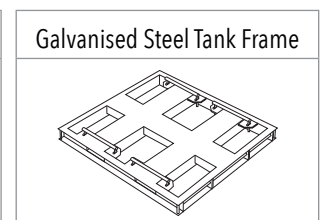
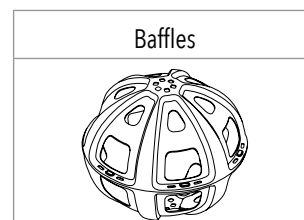

*Various outlet types and sizes also available, please contact sales for a free quote.

COLOURS AVAILABLE

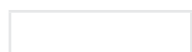

Natural

NB: Colours may vary due to screen and printer calibrations.

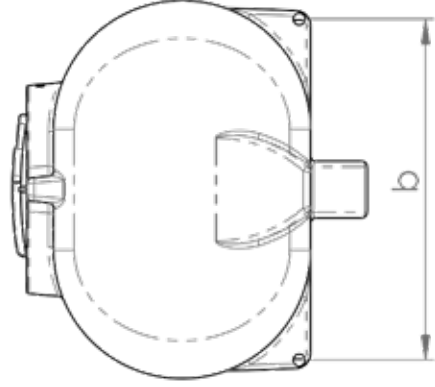
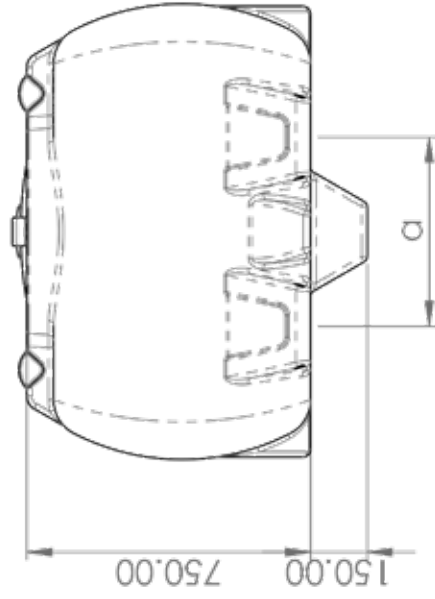
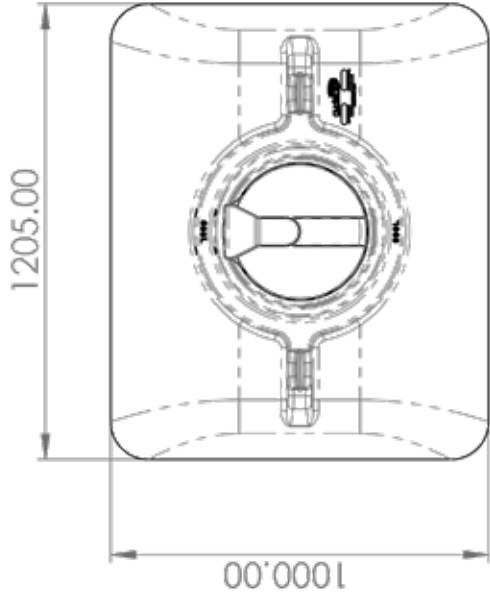

Leg Pitch (a)	Foot Pin Pitch (b)
500 mm	902 mm



PRODUCT CODE:

PTCTFE600

DESCRIPTION:

600 LITRE LIQUID FERTILISER TRANSPORT TANK