

PRODUCT SHEET



TANK	
LENGTH	5030 MM
WIDTH	2380 MM
HEIGHT	2060 MM

**PRODUCT CODE:
PTCTMO18000**

18,000L MOLASSES TRANSPORT TANK

FEATURES

- Spill prevention shroud with 455mm hinged lid
- Heavy duty construction (built to last)
- Manufactured from UV stabilised virgin grade materials (not recycled)
- Secure mounting points in each leg
- Complies with relevant Australian Standards
- Australian Made - Australian Owned

FREE INCLUSIONS

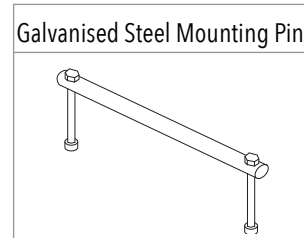
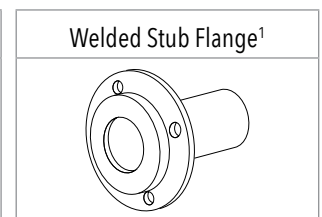
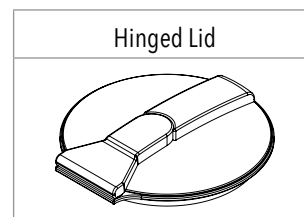

¹ Welded Stub Flange sizes available in 3", 4" and 6"

*Inclusions may change without notice, check with sales prior to ordering.

OPTIONAL EXTRAS

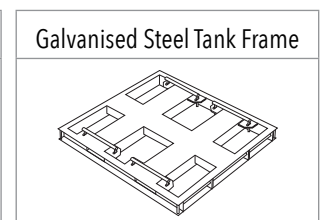
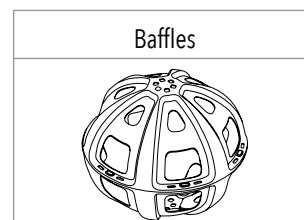

*Various outlet types and sizes also available, please contact sales for a free quote.

COLOURS AVAILABLE



Black

NB: Colours may vary due to screen and printer calibrations.

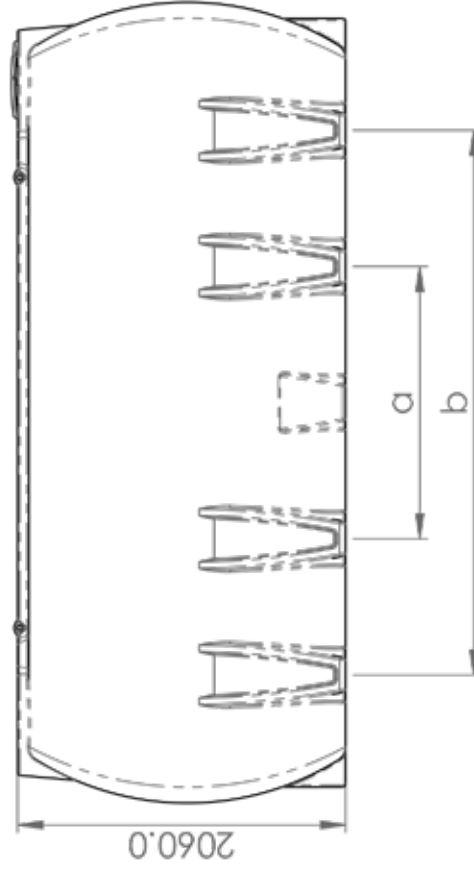
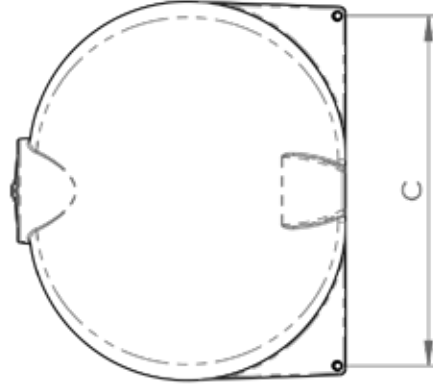
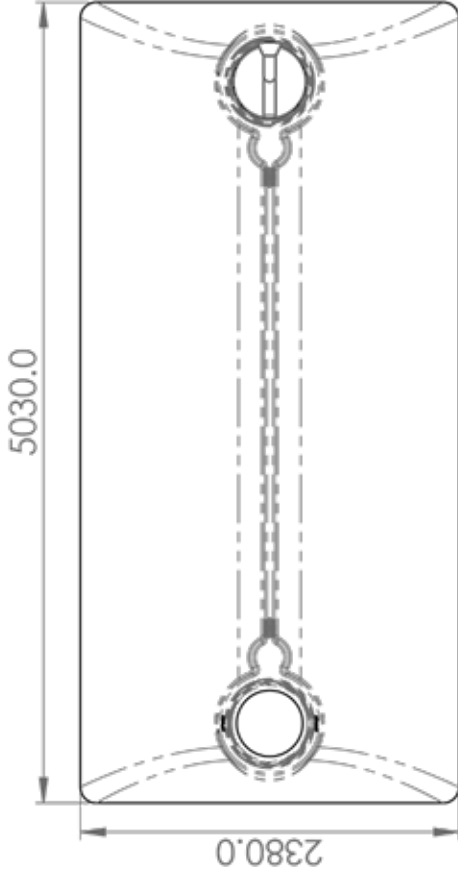
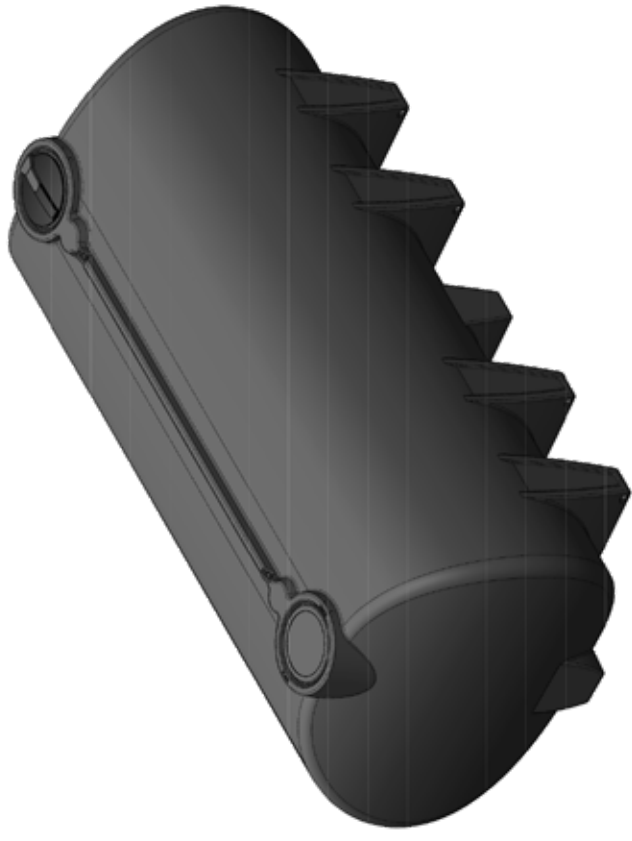

Leg Pitch (a)	Leg Pitch (b)	Foot Pin Pitch (c)
1710 mm	3340 mm	2200 mm



PRODUCT CODE:

PTCTMO18000

DESCRIPTION:

18000 LITRE MOLASSES CARTAGE TANK