

PRODUCT SHEET



TANK	
LENGTH	3200 MM
WIDTH	1900 MM
HEIGHT	1540 MM

**PRODUCT CODE:
PTCTM07000**

7,000L MOLASSES TRANSPORT TANK

FEATURES

- Spill prevention shroud with 455mm hinged lid
- Heavy duty construction (built to last)
- Manufactured from UV stabilised virgin grade materials (not recycled)
- Secure mounting points in each leg
- Complies with relevant Australian Standards
- Australian Made - Australian Owned
- 2 year warranty

FREE INCLUSIONS

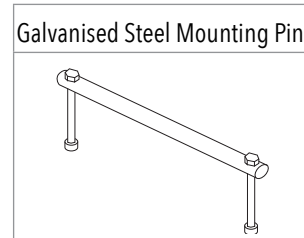
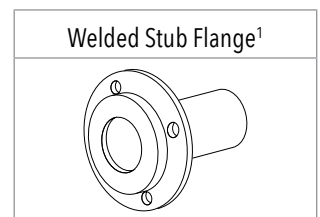
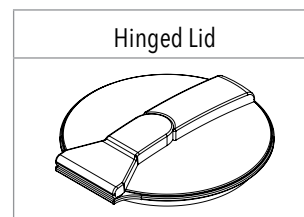

¹ Welded Stub Flange sizes available in 3", 4" and 6"

*Inclusions may change without notice, check with sales prior to ordering.

OPTIONAL EXTRAS

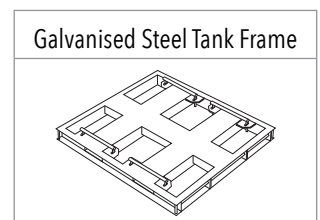
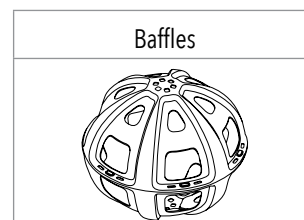

*Various outlet types and sizes also available, please contact sales for a free quote.

COLOURS AVAILABLE



Black

NB: Colours may vary due to screen and printer calibrations.

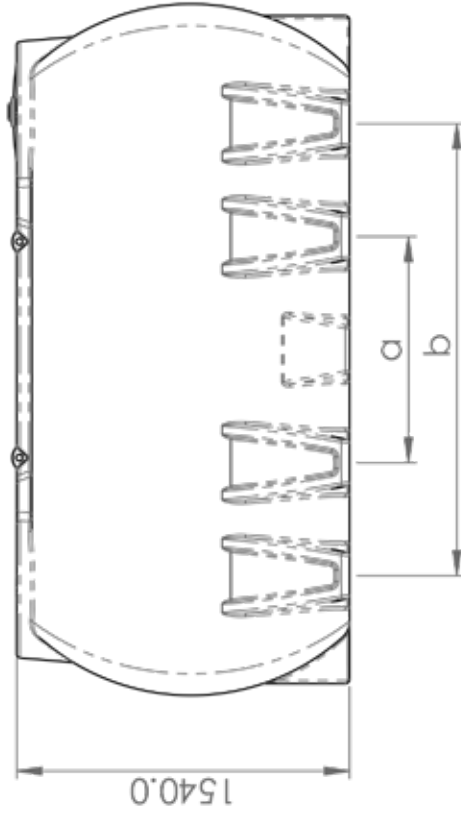
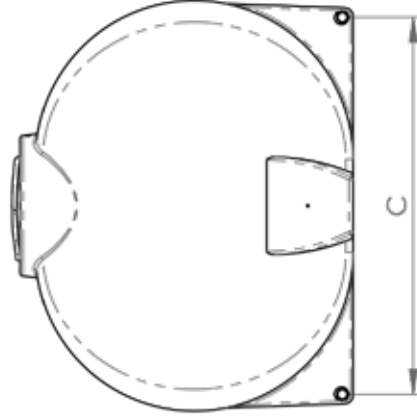
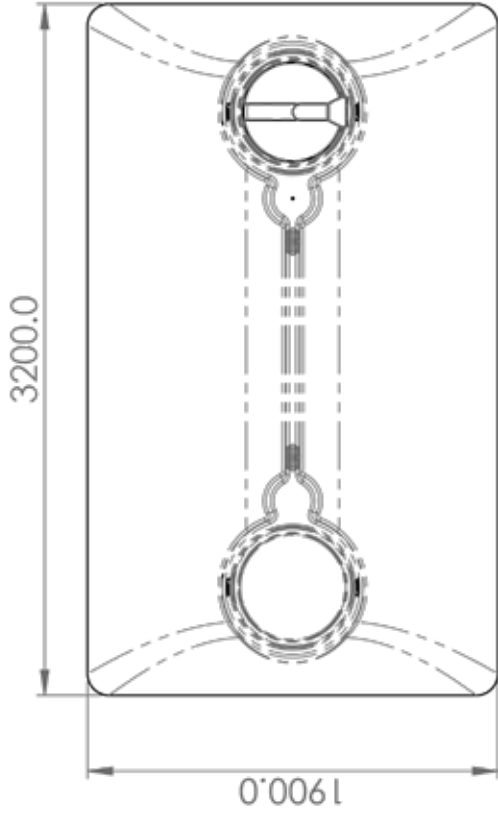

Leg Pitch (a)	Leg Pitch (b)	Foot Pin Pitch (c)
1045 mm	2110 mm	1745 mm



PRODUCT CODE:

PTCTMO7000

DESCRIPTION:

7000 LITRE MOLASSES CARTAGE TANK